

Technische fiche :

MRT 2260

VISION +





MRT 2260 Gemaakt op 23 augustus 2022 om 15:34:37 UTC

Capacities		Metrisch
Max. capacity		6000 kg
Max. lifting height		21.80 m
Max. outreach		18.20 m
Weight and dimensions		
Overall width	b1	2.50 m
Overall height	h17	3.10 m
Overall cab width	b4	0.96 m
Ground clearance	m4	0.36 m
Wheelbase	y	3.05 m
Tilt-up angle	a4	12 °
Tilt-down angle	a5	112 °
Turret rotation		360 °
Overall weight		18000 kg
Forks length / width / section	l / e / s	1200 mm x 100 mm x 60 mm
Wheels		
Standard tyres		445/65 R22,5
Drive wheels (front / rear)		2 / 2
Steering mode		2 wheel steer, 4 wheel steer, Crab mode
Stabilisers		
Stabs Type		Telescopic Duplex
Controls with stabs		Stabs Commands Individual or Simultaneous
Engine		
Engine brand		Yanmar
Engine norm		Stage V / Tier 4
Engine model		4TN107FHT-6SMU1
I.C. Engine power rating / Power (kW)		156 Hp / 115 kW
Max. torque / Engine rotation (min)		602 Nm @ 1500 rpm
Number of cylinders - Capacity of cylinders		4 - 4567 cm³
Engine cooling system		Water cooled
Number of batteries / Battery / Batteries capacity		2 x 12 V / 120 Ah
Battery starting current		(EN)850 A
Transmission		
Transmission type		Hydrostatic with Speedshift
Gearbox / Number of gears (forward) / Number of gears (reverse)		Speedshift 2 / 2
Max. travel speed		40 km/h
Parking brake		Automatic negative parking brake
Service brake		Oil-immersed multi-discs braking on front & rear axles
Performances		
Gradeability (laden / unladen)		40.40 % / 45.57 %
Hydraulics		
Hydraulic pump type		Variable displacement pump
Hydraulic flow		185 l/min
Hydraulic Pressure		350 bar
Tank capacities		
Engine oil		13 l
Hydraulic oil		260 l
Fuel tank		270 l
Diesel Exhaust fluid (AdBlue® type)		24 l
Miscellaneous		
Steering wheels (front / rear)		2 / 2
Controls		2 Joysticks
Safety cab homologation		Cabin ROPS - FOPS Level 2
Attachment recognition system (E-Reco)		Standard

MRT 2260 - Tekening met afmetingen

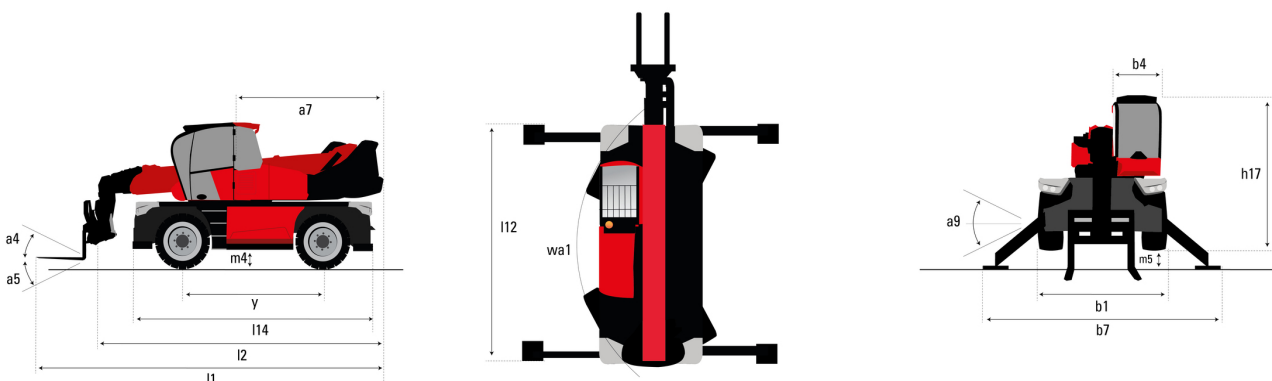



MRT 2260 Gemaakt op 23 augustus 2022 om 15:34:37 UTC

Andere gegevens		Metrisch
Overall length (with forks)	l1	8.17 m
Length to face of forks	l2	6.97 m
Length of frame	l14	5.69 m
Wheelbase	y	3.05 m
Ground clearance	m4	0.36 m
Counterweight offset (turret at 90°)	a7	2.97 m
Tilt-up angle	a4	12°
Tilt-down angle	a5	112°
Overall length at stabilisers	l12	5.30 m
External turning radius (over tyres)	Wa1	4.22 m
Overall width	b1	2.50 m
Overall width with stabilisers extended	b7	5.78 m
Overall cab width	b4	0.96 m
Overall height	h17	3.10 m
Frame levelling corrector	a9	+/- 7°
Ground clearance under front tires on stabilizers	m5	0.43 m

MRT 2260 - Lastendiagram

Machine on tyres with forks Metric

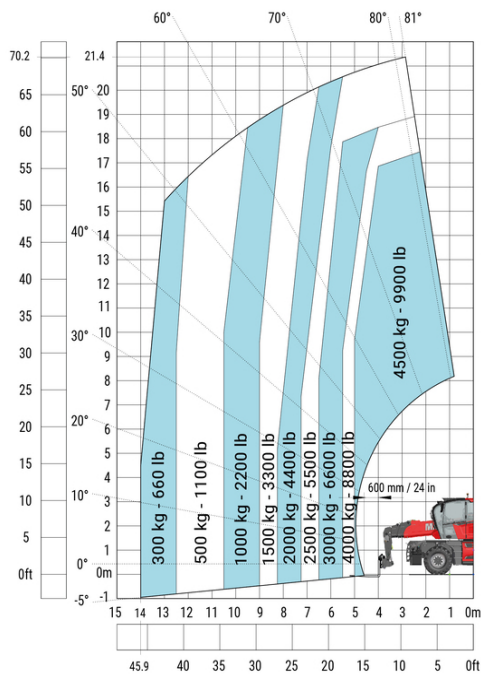

Machine on lowered stabilisers with forks Metric

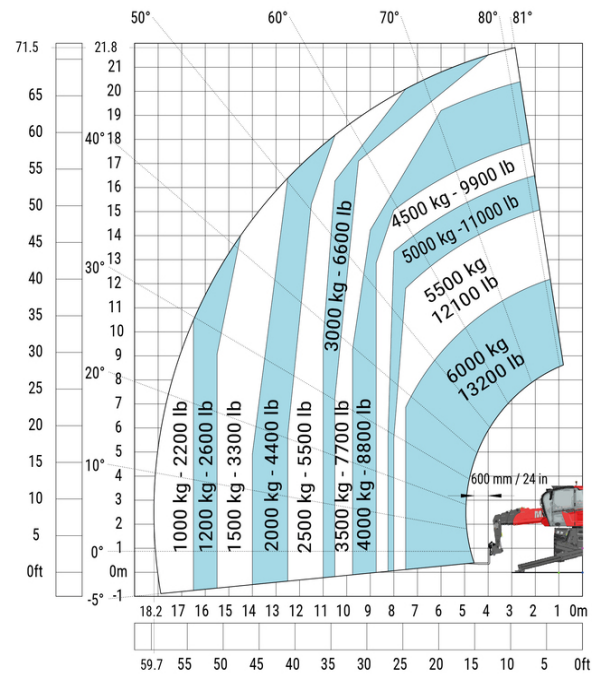

Machine on lowered stabilisers with 1500 kg jib Metric

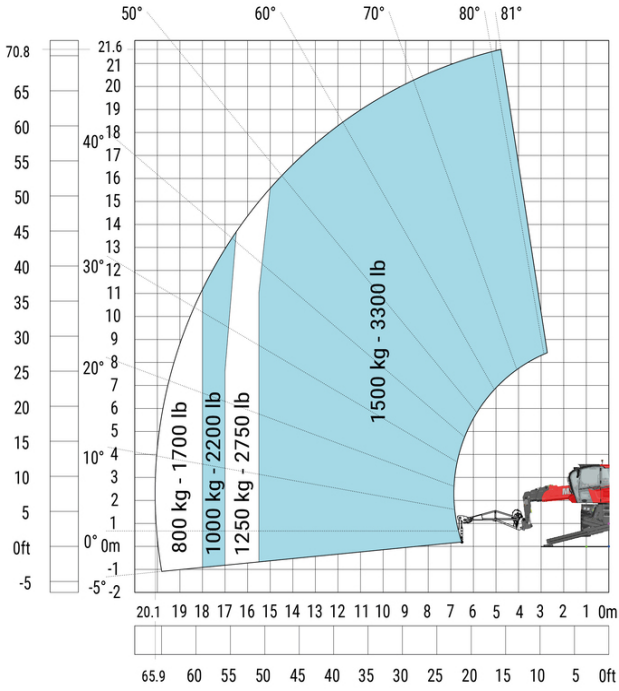

Machine on lowered stabilisers with 365 kg platform Metric

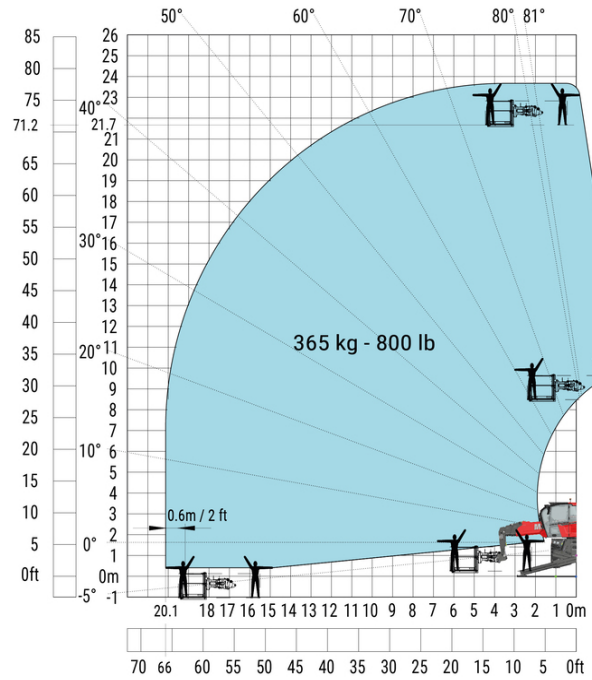

Machine on lowered stabilisers with 1000 kg platform Metric

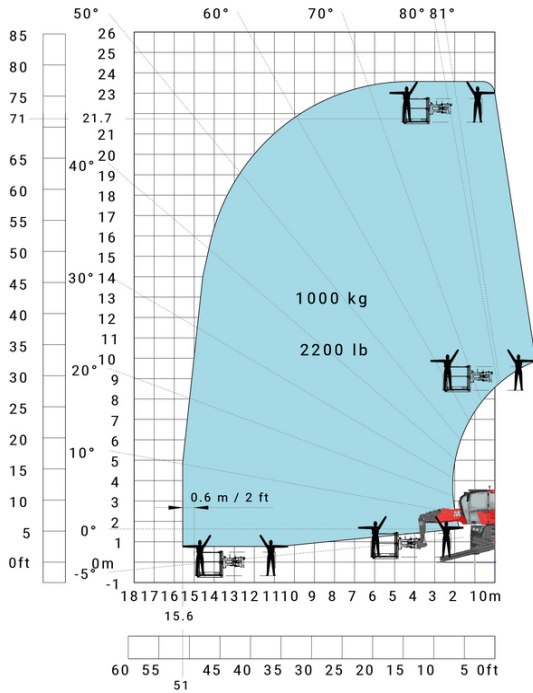

Machine on lowered stabilisers with 3D positive Metric

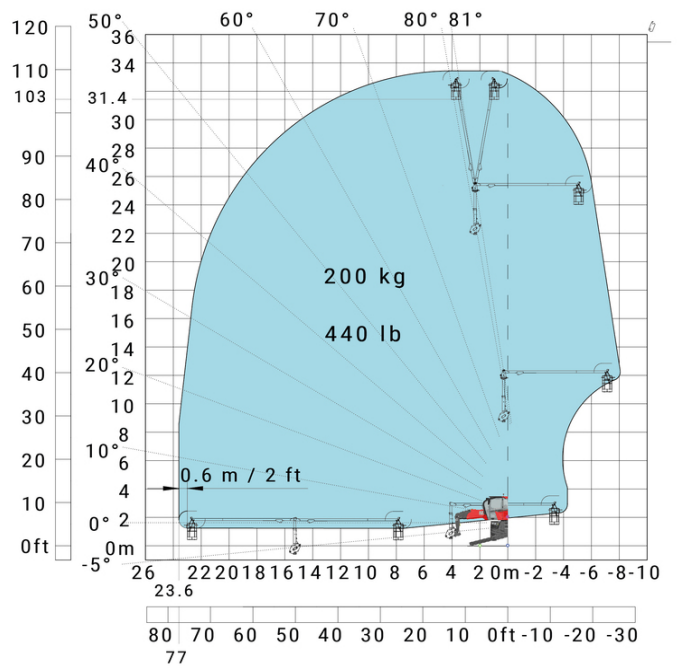

Machine on lowered stabilisers with 3D negative Metric

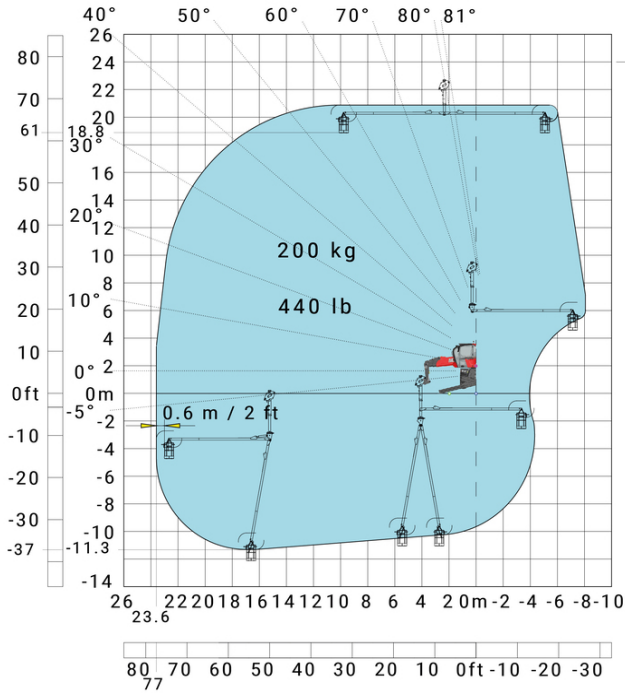

Machine on lowered stabilisers with extensible jib with winch (Metric)

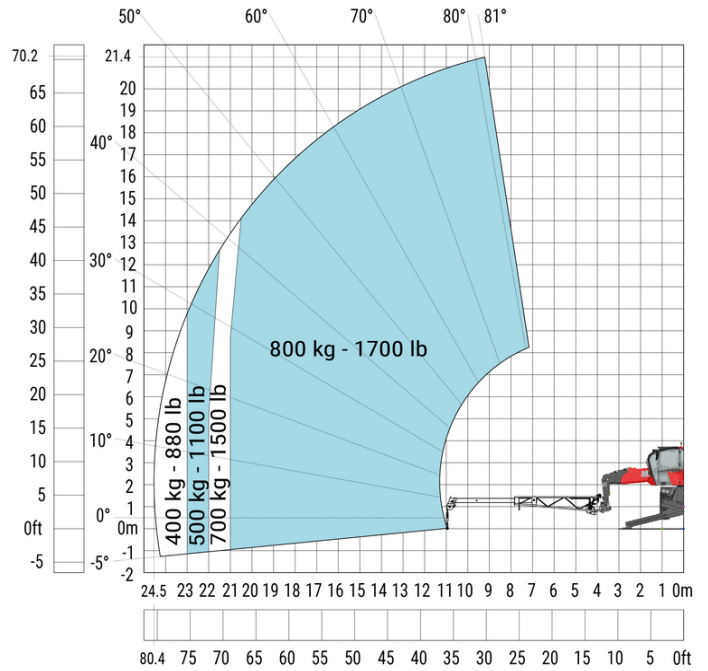

Machine on lowered stabilisers with hook 6000 kg (Metric)

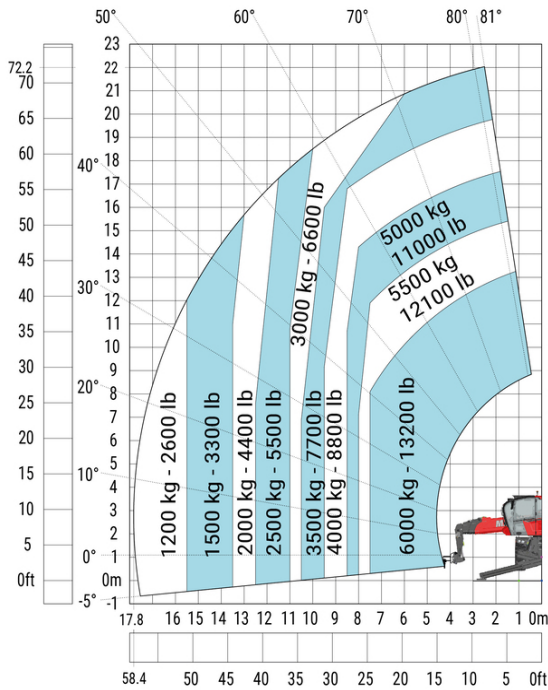

Machine on lowered stabilisers with winch 6000 kg (Metric)

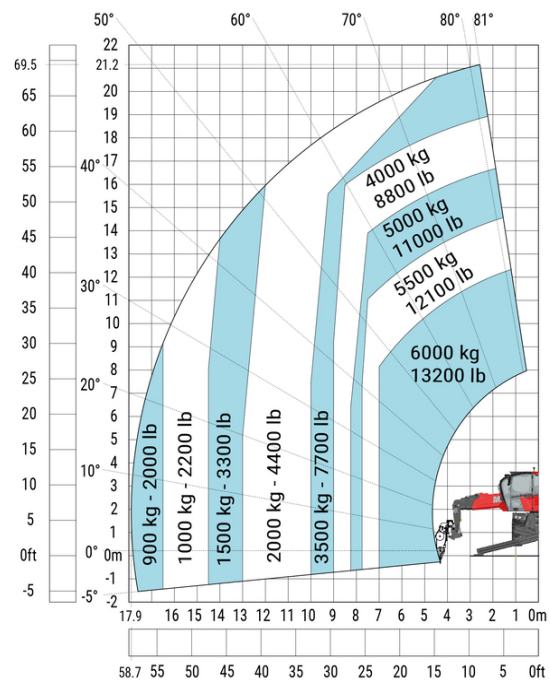

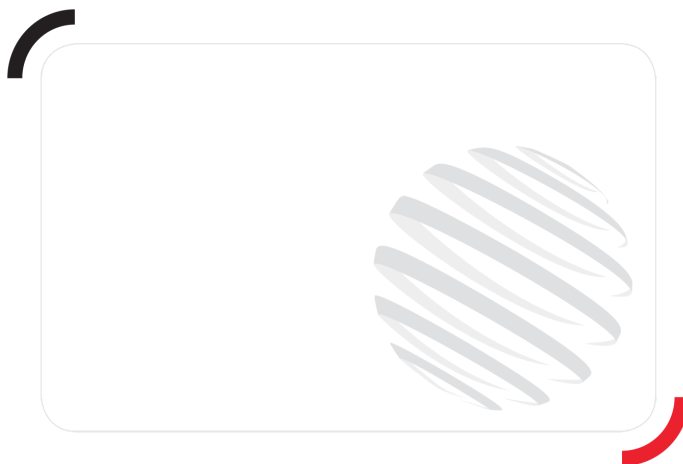

Siège Social

430 rue de l'Aubinière - 44150 Ancenis Cedex - France

Tel: +33(0)2 40 09 10 11 - Fax: +33 (0)2 40 09 10 97

www.manitou.com

Deze publicatie geeft een beschrijving van de versies en configuratiemogelijkheden van de Manitou-producten, waarvan de uitrusting kan verschillen. De afgebeelde uitrustingen in deze brochure kunnen standaard, optioneel of niet leverbaar zijn, afhankelijk van de versies. Manitou behoudt zich het recht voor om op te allen tijde en zonder voorafgaande kennisgeving de vermelde specificaties te wijzigen. De weergegeven specificaties zijn niet bindend voor de fabrikant. Voor meer bijzonderheden kunt u uw Manitou dealer raadplegen. Dit document is niet contractueel. De presentatie van de producten is niet contractueel. Specificatielijst is niet uitputtend. De logo's, evenals de visuele identiteit van de onderneming zijn eigendom van Manitou en mogen niet zonder toestemming worden gebruikt. Alle rechten voorbehouden. De foto's en schema's in deze brochure zijn bedoeld als informatie en zijn indicatief.

MANITOU BF NV - Naamloze vennootschap met raad van bestuur - Kapitaal: 39 668 399 euro - 857 802 508 RCS Nantes